



Power & Filtration Solutions

WASP FUEL POLISHING RANGE



Product Catalogue

W-HL/PFS/WBW-10AC Ranges

rev2102





CONTENTS

Introduction	3
What is Fuel Polishing?	3
What can Fuel Polishing do for me?.....	4
The best protection	4
Which system do I need?.....	5
W-HL60	6
W-PFS Range.....	7
W-PFS-008	9
W-PFS-010	10
W-PFS-014	11
W-PFS-026	12
W-PFS-040	13
W-PFS-060	14
W-PFS-120	15
W-PFS-240	16
W-PFS add-on options.....	17
W-PFS Service packs and spares	20
Custom built systems	22
WB Range.....	23
How does the WB range work?	23
WB range service interval	23
WB range installation guide	24
WB-10.....	25
WB-25.....	26
WB-40.....	27
WB add on options	28
WB Custom built systems	29
W10AC Fuel Polishing Range	30

Notes
 Flow rates and current draw values will depend on installation details and are quoted as nominal values for reference. Narrow pipework, high lifts/heads and similar mechanical constrictions will affect the machines flow rate and current draw.

All images, data, facts and figures shown in this document are for representation only and are subject to change. The manufacturer reserves the right to change specifications without notice.

All information in this document is only for reference.

Reproduction in any form is not permitted without the prior written permission of WASP PFS Ltd.

E&OE



WASP PFS Ltd
 25 North Orbital Commercial Park, Napsbury Lane,
 St Albans, Herts, UK
 sales@wasp-pfs.com
 +44(0)1923 606600

WASP Holdings Inc.
 809 W. Detweiller Dr. Peoria, IL, 61615, USA
 americasales@wasp-pfs.com
 +1(0) 309-981-0609

www.wasp-pfs.com

Introduction

When you rely on uninterrupted back up power in case of a mains power failure, an engine for your truck, yacht, bus or tractor, or whatever you need your diesel/EN590/HVO/Biodiesel fuel for, it is essential the stored fuel to power your generator remains clean to prevent complete power failure.

The results of complete power failure depend on the industry, it could for example be a cost of millions of pounds in a data centre, a loss of all chilled food stored in a supermarket, power failure on a marine vessel or devastatingly a cost of lives in a hospital.

Fuel could be stored for months to years without being used. In that time, fuel can become contaminated with the likes of water and bacteria, resulting in engine failure or damage.

In the case of a UPS (Uninterrupted Power Supply), when a power cut does happen, the backup system fails to work leaving a complete loss of power and possible devastating consequences.

Marine vessels or boats can also be affected when refuelling in countries without strict fuel specifications. Any water or contamination in the fuel can cause engine issues.

What is Fuel Polishing?

Fuel polishing is the technological cleaning process which removes water and particulates from diesel/HVO fuel which is stored for the medium to long term.

This process keeps the fuel at optimum condition and helps prevent fuel related engine and generator failures.

There are many different stages in the fuel polishing process which follow one after the other in a specific sequence. This ensures the water, sludge, sediment, bacteria and other contaminate is removed from the fuel.

A single fuel polishing system is capable of maintaining fuel quality, protecting your engine/generator from fuel related breakdowns and making the system more efficient through the removal of impurities.



The unit can communicate its progress, status and history with you via the touch screen, the built in BMS volt free communication, Ethernet screen sharing, RS485 and via the reporting/export function. Further communication options allow for Modbus, Profibus, Bacnet, Canopen and other field bus protocols as well.

WASP PFS Ltd have four fuel polishing ranges.

Platinum

The **W-HL range**, specifically designed for high lift (underground) tank applications. 2 micron, self-priming units.

Gold

The **W-PFS Premium range** which remove contamination and both free and emulsified water to 2 micron. Controlled with an interactive touch screen, BMS connectivity and have a large catalogue of “add-ons” available.

Silver

The **WB Classic range** which removes contamination and free water to 10 micron. An ideal entry level system to suit basic cleaning needs and budget. Ranging from 10 to 40 litres per minute, all WASP WB systems have the same key features in common. Simplicity, ease of use and a precise efficient functionality are vital.

Bronze

The **W10AC range** for smaller tanks, day tanks and for remote sites where simplicity is required, whilst maintaining a thorough fuel clean.



What can Fuel Polishing do for me?

Good fuel housekeeping is critical to the success of your facility/vehicle/vessel. Without fuel in optimum condition, you are open to potential engine failure

There are three key functions of a fuel polishing system

1. System recovery
Cleaning of the fuel in the tank; returning it to a useable state and maintaining EN590 level pass levels for particulate and water
2. System maintenance
Fuel optimisation, maintaining the quality and ensuring it is ready for use when called on
3. Analytics
Collating of internal and external data from the system, its sensors, and any external connections to provide a picture of fuel and system efficiency over time.

By removing the contamination which can and will cause fuel breakdowns, your fuel system, generator, engine, and power are all protected. Fuel polishing also has the advantage of maintaining your fuel quality, preventing premature fuel degradation, protecting your filter systems, and protecting your engine from poor quality fuel issues, for example injector damage. Which causes inefficiencies or even failures which will stop an engine or generator from working all together.

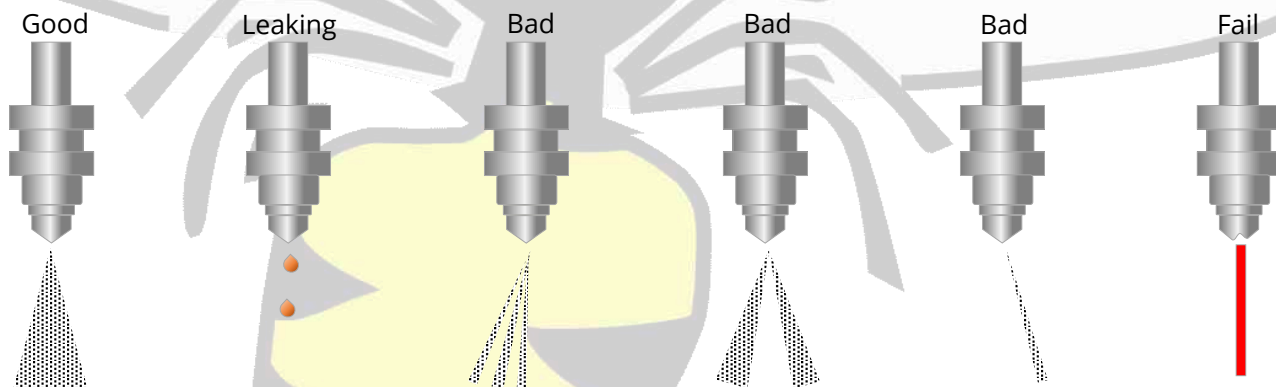

The best protection

With over 30 years' experience, WASP are the pioneers of the fuel polishing industry. We are constantly testing and innovating new media as well as being ISO9001:2015 certified, which makes us the obvious choice for getting quality built products and service.

Our systems are better developed, faster, more efficient and have significantly more functionality than any other in the market today.

What makes us unique is by **designing and building our own systems**, we have the **flexibility and expertise** to design and manufacture products specific to your **budget, requirements and specifications**.





Which system do I need?

If you are new to fuel polishing, trying to decipher which system will best suit your requirements and budget can be quite daunting.

The system you require will vary based on the following factors:

- Tank size and fuel amount
- The speed which it needs to be cleaned
- Power (12v, 24v, 220v, 110v)
- Type of generator/engine
- Location of fuel tank i.e. internal or external
- Any of our "Add-On" features

The screenshot shows the WASP Pure Fuel Systems website. At the top, there is a navigation menu with links for HOME, PRODUCTS, GALLERY & MEDIA, INFO, INTERNATIONAL, COMPANY INFO, CONTACT US, and a PRODUCT SELECTOR button. Below the navigation is a breadcrumb trail: HOME > PRODUCT SELECTOR WIDGET. The main heading is "Product Selector Widget" with the subtext "Select the right system for you".

The widget is titled "Fuel Cleaning Product Selector Widget" and contains the following text: "Our Brand New Product Selector Widget has been developed to make selecting the right Fuel Cleaning Unit for you quick and easy. To use the simple widget, simply select the relevant three variables (Fuel tank size, Power Options and Required Installation) from the drop down options below and click search. The relevant models meeting the specified criteria will be listed."

Below the text are three dropdown menus: "10,001 to 30,000 l", "220v AC", and "Portable (on trolley)". A "Search" button is located to the right of the third dropdown. Below the search options, there is contact information: "Of course, if you would prefer to discuss your options with a member of the WASP PFS Ltd Sales Team, please do not hesitate to contact us on: +44(0)1923806 600 or email: sales@wasp-pfs.com." At the bottom of the widget are four buttons: "W-PFS Premium Fuel Cleaning", "WB Classic Fuel Cleaning", "Gallery", and "Guide to Fuel Polishing".

We highly recommend using the "Product Selector" tool on our website, www.wasp-pfs.com as it has been designed to ensure finding your ideal system is as easy as possible.

The infographic is titled "Choosing your ideal system.. is easy as 1, 2, 3" and includes a link "Need help? Contact us". It is divided into three columns:

- CLEANING SPEED**: Represented by a lightning bolt icon, with a range of "From 8 lit/min - 240 lit/min".
- POWER**: Represented by a battery icon, with options "12vDC, 24v DC or 220v AC?".
- ADD-ONS**: Represented by a plus sign icon, with examples "Need a drip tray, multi-tank cleaning, MODBUS, heating, cooling,..."

High Lift capacity Diesel fuel cleaning system.

Up to 70lit/min fuel polishing system, nominal flow rate 60lit/min, cleaning fuel to 2 micron absolute, removing both free and emulsified water, bacteria and particulate

- Advanced, high speed AC system, providing full control system and monitoring
- Manual, Automatic (timer) and BMS control system
- Unique easy-priming system
- Integrated Fuel Flow Indicator
- Recirculation or transfer action
- 99.9 % free water removal in a single pass
- 99 % emulsified water removal in a single pass
- 2 micron final polish/fuel cleaning
- Tank sizes up to 125000 litres



Base Model (wall mounted)	W-HL060W-220
Max flow rate	70 lit/min (18.5 US gal/min)
Recommended tank size	Up to 125,000 litres (33,000 US gallons)
Finish options	IP55 Wall mounted, Frame Mounted, Enclosure
Particulate removal to	2 Micron
Control unit	Touch screen control
BMS** outputs	6
BMS** inputs	2
Power options	220v 50hz 1ph AC / 110v 60hz 1ph AC available
Fuse	3a
Typical current	1a
Suction capability	6-7m max vertical lift, over 3m requires non-return valve fitted
Port sizes	1.5" BSP-P / NPT
Pump body	Steel
Pump type	Sliding Vane
Shaft	316 Stainless steel
Seal	Viton/FKM
Dimensions *	1000x1500x400mm (39x59x16in)
Weight *	85kg est. (187lbs)

CLEANING SPEED

Up to 70 lit/min - ideal for tank sizes up to 125,000 litres

POWER

220vAC
110vAc (option)

INSTALLATION

Wall Mounted, stair climbing trolley, weather-proof casing, towing unit, frame mounted

ADD-ONS

Absolute Polishing (to 0.5 micron), auto biocide dosing, WASP Connect (remote control of unit), particulate counter, Auto priming pumps, auto water drains, mobile & internet connectivity, drip tray, auto change-over for multiple fuel tanks, ModBus and FieldBus options.

Performance

1.5" hose, 0.5m lift, 77 lit/min
1.5" hose, 5m lift, 72 lit/min
1" hose, 3.5m lift, 62 lit/min
1" hose, 5m lift, 58 lit/min
Figures May 2020, tested with clean filter elements and 2-year-old diesel.

* Measurements are for the wall mounted version. Please enquire for measurements for others.
**BMS -Building Management System

How Does It Work?

By removing the bacterial content and neutralising any residual micro-fine particles, the infection simply cannot return; thus ensuring that the WASP Pure Fuel Systems are not only the most effective way of maintaining fuel quality, but is environmentally friendly too, as no chemicals or biocides are used in this process.



A Modular Approach

A WASP fuel polishing system can be adapted to perform many more tasks.

Via our modular approach to fuel cleaning, it is possible to adapt the already powerful standard features of a fuel polishing system to add even more functionality via our optional “add-ons”.

Standard Features	Optional Features	Part No	Notes
2-micron cleaning	2 Tank Automatic Changeover System	W-PFS-2TACO	Clean 2 tanks with one polishing system
Free water removal	3 Tank Automatic Changeover System	W-PFS-3TACO	Clean 3 tanks with one polishing system
Emulsified water removal	4 Tank Automatic Changeover System	W-PFS-4TACO	Clean 4 tanks with one polishing system
Touch screen control	5 Tank Automatic Changeover System	W-PFS-5TACO	Clean 5 tanks with one polishing system
Reporting function	Automatic Chemical Dosing System	W-PFS-Dosing	Dose fuel additives as part of the clean
Data capture and export	Automatic Water Drainage System	W-PFS-AutoDrain	Eject water autonomously
Trend graphs	Modbus BMS connection	W-PFS-Modbus	BMS communication via modbus Profibus, bacnet, canopen and others are also available
Ethernet screen sharing	Drip Tray	W-PFS-Driptray	Stainless steel tray to catch spills
Volt free BMS connection	Automatic Priming Stage	W-PFS-AutoPrime	Autonomously primes your unit
RS485 communication	Particulate Counter	W-PFS-Particulate	Live ISO4406 particulate test results
	Frame Mounted	W-PFS-Frame	Stainless steel frame for floor mounting
	Enclosure	W-PFS-Enclosure	Stainless steel enclosure, heater, leak detection
	Portable option	W-PFS-Portable	10-40 lpm systems can be made portable
	Fuel Flow Indicator	W-PFS-FFI	Visual indication of fuel flow

Example combinations

- W-PFS-010-W-220vac + 2TACO 10 lit/min fuel polishing system, capable of cleaning fuel in two tanks autonomously
- W-PFS-040-W-220vac + AutoDrain 40 lit/min fuel polishing system, which will drain water automatically
- W-PFS-026-W-220vac + Enclosure 26 lit/min fuel polishing system, with IP54 stainless steel enclosure, including leak detection system, thermostatic ventilation, and frost protection heater.



Installation Notes

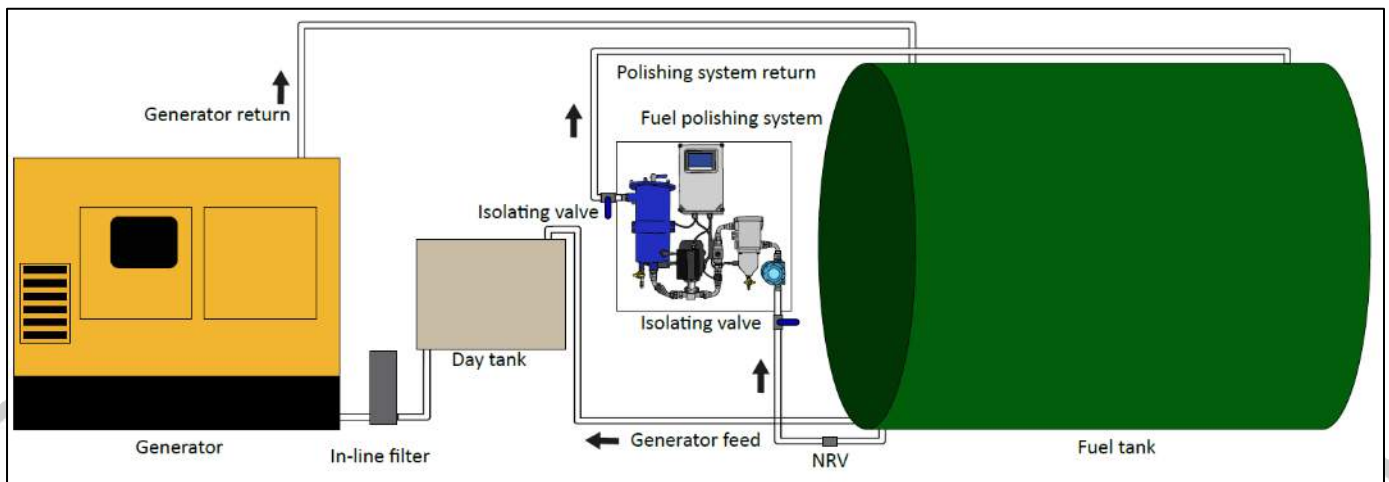

- Ensure the system is securely fastened to a wall or other suitable solid structure
- The unit should have unique pipe work, i.e. not the feed to the engine.
- The input to the WASP system should feed from the bottom of the fuel tank (via a ball valve and a light spring (0.03bar cracking) foot valve / non-return valve).
- The system should pick-up fuel from the lowest point of the tank at one end, (below the level of the fuel feed to your engine) and ideally return it to the highest point at the opposite end
- In any typical fuel tank, the pipe feeding fuel to the engine is not at the bottom, however to successfully clean fuel, the pickup pipe going to the W-PFS unit should be right at the bottom of the tank, below the engine feed
- The output should return to the tank at the top, ideally the opposite end to the input
- All pipes should be free from leaks
- The unit can be controlled via BMS (Building Management System), however it is capable of self-operation and monitoring
- System must be primed before use and operation. It must also be primed after servicing; although with the aforementioned foot or non-return valve installed, priming should only need to be done once, after installation
- With power applied, please ensure the system's time and date have been correctly set
- We recommend an internal pipe diameter of 3/4" for the 008/010 models, 1" for the 014/026/040 models, and 1.5" for the 060 units.
- Larger pipe diameters will assist the unit as this reduces the frictional losses.
- Small pipe diameters, long pipe runs or multiple and tight bends in the pipe work will cause high frictional losses and hence the system will run slower, or in extreme cases cause it to stop. Likewise, high fuel lifts or fuel heads will also cause a unit to run slower than its maximum



Up to 8 litres per minute fuel polishing system, cleaning fuel to 2 micron, removing both free and emulsified water, bacteria and particulate.

- Diesel/EN590/HVO/Biodiesel fuel polishing system
- Advanced, high speed DC system, providing full control system and monitoring
- Manual, Automatic (timer) and BMS control system
- Fuel conditioning stage for anti-bacterial action
- Patented centrifugal removal process
- Recirculation or transfer action
- 99.9 % free water removal in a single pass
- 99 % emulsified water removal in a single pass
- 2 micron final polish/fuel cleaning
- Tank sizes up to 10,000 litres, cleaning up to 8 lit/min
- 24vDC (12v DC available as an option with some feature changes)



Base Model (wall mounted)	W-PFS-008-W-24vdc (12v available on request)
Max flow rate	up to 8 lit/min, 2.1 US gal/min
Recommended tank size	up to 10,000 Litres (2650 us gal)
Finish options	Wall Mounted, Enclosure, Trolley, Frame mounted, towing unit
Particulate removal to	2 Micron
Control unit	Touch screen control
BMS** outputs	6
BMS** inputs	2
Power options	24v DC
Fuse	3a
Typical current	1a
Suction capability	1.5m vertical lift, over 5m with non-return valve fitted and when primed
Port sizes	3/4" BSP-P or NPT
Pump body	Steel
Pump type	PTFE Gear
Shaft	316 Stainless steel
Seal	Fluoroelastomer
Dimensions *	700x700x250mm (27.5x27.5x10in)
Weight *	18kg / 39lbs approx.



CLEANING SPEED

Up to 8 lit/min - ideal for tank sizes up to 10,000 litres



POWER

24vDC
12vDC



INSTALLATION

Wall Mounted, stair climbing trolley, weather-proof casing, towing unit, frame mounted



ADD-ONS

Absolute Polishing (to 0.5 micron), auto biocide dosing, WASP Connect (remote control of unit), particulate counter, Auto priming pumps, auto water drains, mobile & internet connectivity, drip tray, auto change-over for multiple fuel tanks, ModBus and FieldBus options.

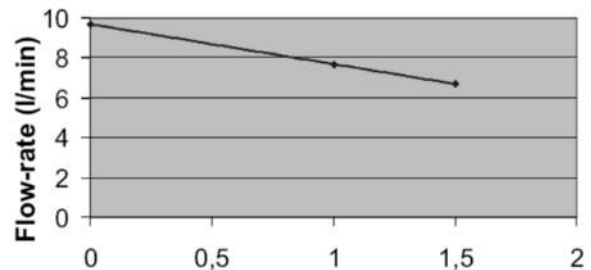

* Measurements are for the wall mounted version. Please enquire for measurements for others.
**BMS -Building Management System



W-PFS-010

Up to 10 litres per minute fuel polishing system, cleaning fuel to 2 micron, removing both free and emulsified water, bacteria and particulate

- Diesel/EN590/HVO/Biodiesel fuel polishing system
- Advanced, high speed DC system, providing full control system and monitoring
- Manual, Automatic (timer) and BMS control system
- Fuel conditioning stage for anti-bacterial action
- Patented centrifugal removal process
- Recirculation or transfer action
- 99.9 % free water removal in a single pass
- 99 % emulsified water removal in a single pass
- 2 micron final polish/fuel cleaning
- Tank sizes up to 12,500 litres
- Up to 10 litres per minute



Base Model (wall mounted)	W-PFS-010-W-220vac	W-PFS-010-W-110vac
Max flow rate	up to 10 lit/min, 2.6 US gal/min***	
Recommended tank size	Up to 12,500 litres (3,300 us gallons)	
Finish options	Wall Mounted, Enclosure, Frame, Trolley, Towing Unit	
Particulate removal to	2 Micron	
Control unit	Touch screen control	
BMS** outputs	6	
BMS** inputs	2	
Power options	220v 50hz 1ph AC	110v 60hz 1ph AC
Fuse	3a	6a***
Typical current	1a	2a***
Suction capability	1.5m vertical lift, 5m with non-return valve fitted and when primed	
Port sizes	3/4" BSP-P or NPT	
Pump body	Steel	
Pump type	PTFE Gear	
Shaft	316 Stainless steel	
Seal	Fluoroelastomer	
Dimensions *	700x700x350mm/27.5x27.5x14in (900x800x400mm / 35x31.5x16in when in enclosure)	
Weight *	21kg / 46lbs approx. (55kg / 121 lbs approx. when in enclosure)	

CLEANING SPEED
Up to 10 lit/min - ideal for tank sizes up to 12,500 litres

POWER
220vAC
110vAC

ADD-ONS
Absolute Polishing (to 0.5 micron), auto biocide dosing, WASP Connect (remote control of unit), particulate counter, Auto priming pumps, auto water drains, mobile & internet connectivity, drip tray, auto change-over for multiple fuel tanks, ModBus and FieldBus options

INSTALLATION
Wall Mounted, stair climbing trolley, weather-proof casing, towing unit, frame mounted

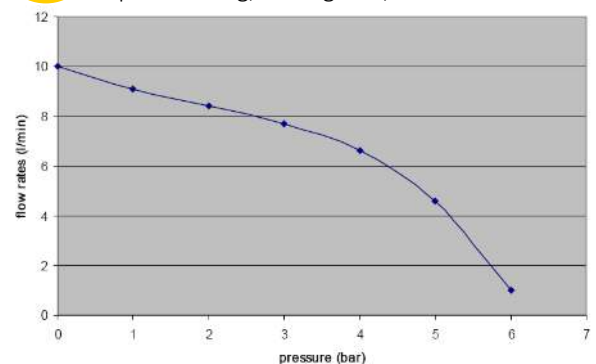

* Measurements are for the wall mounted version. Please enquire for measurements for others.

**BMS -Building Management System

*** approximate values





W-PFS-014

Up to 14 litres per minute fuel polishing system, cleaning fuel to 2 micron, removing both free and emulsified water, bacteria and particulate.

- Diesel/EN590/HVO/Biodiesel fuel polishing system
- Advanced, high speed DC system, providing full control system and monitoring
- Manual, Automatic (timer) and BMS control system
- Fuel conditioning stage for anti-bacterial action
- Patented centrifugal removal process
- Recirculation or transfer action
- 99.9 % free water removal in a single pass
- 99 % emulsified water removal in a single pass
- 2 micron final polish/fuel cleaning
- Tank sizes 7,500 to 20,000 litres
- Up to 14 litres per minute



Base Model (wall mounted)	W-PFS-014-W-24vdc (12v available on request)
Max flow rate	up to 14 lit/min, 3.7 US gal/min
Recommended tank size	up to 20,000 litres (5300 us gallons)
Finish options	24v DC
Particulate removal to	Wall Mounted, Enclosure, Trolley, Frame mounted, Towing Unit
Control unit	2 Micron
BMS** outputs	Touch screen control
BMS** inputs	6
Power options	2
Fuse	5a
Typical current	4a
Suction capability	1.5m vertical lift, over 5m with non-return valve fitted and primed
Port sizes	3/4" BSP-P or NPT
Pump body	Steel
Pump type	PTFE Gear
Shaft	316 Stainless steel
Seal	Fluoroelastomer
Dimensions *	700x700x250mm/27.5x27.5x10in
Weight *	19kg / 41lbs approx.



CLEANING SPEED

Up to 14 lit/min ideal for tank sizes from 7,500 - 20,000 L



POWER

12vDC
24vDC



INSTALLATION

Wall Mounted, stair climbing trolley, weather-proof casing, towing unit, frame mounted



ADD-ONS

Absolute Polishing (to 0.5 micron), auto biocide dosing, WASP Connect (remote control of unit), particulate counter, Auto priming pumps, auto water drains, mobile & internet connectivity, drip tray, auto change-over for multiple fuel tanks, ModBus and FieldBus options.

* Measurements above are for the wall mounted version. Please enquire for weights and dimensions for alternative finishes

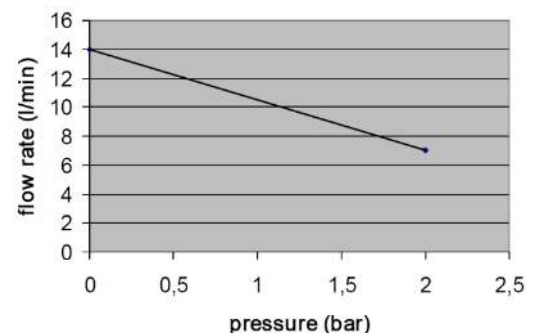



W-PFS-026

Up to 26 litres per minute fuel polishing system, cleaning fuel to 2 micron, removing both free and emulsified water, bacteria and particulate.

- Diesel/EN590/HVO/Biodiesel fuel polishing system
- Advanced, high speed DC system, providing full control system and monitoring
- Manual, Automatic (timer) and BMS control system
- Fuel conditioning stage for anti-bacterial action
- Patented centrifugal removal process
- Recirculation or transfer action
- 99.9 % free water removal in a single pass
- 99 % emulsified water removal in a single pass
- 2 micron final polish/fuel cleaning
- Tank sizes up to 30,000 litres



Base Model (wall mounted)	W-PFS-026-W-220VAC	W-PFS-026-W-110VAC	W-PFS-026-W-24vDC
Max flow rate	up to 26 lit/min, 6.8 US gal/min		
Recommended tank size	10,000 to 30,000 litres		
Finish options	Wall mounted, stair climbing trolley, enclosure, towing unit, frame mounted		
Particulate removal to	2 Micron		
Control unit	Colour touch screen		
BMS** outputs	6		
BMS** inputs	2		
Power options	220v 50hz 1ph AC	110v 60hz 1ph AC	24vDC
Fuse	3a	6a	8a
Typical current	2.5a	5a	5a
Suction capability	1.5m vertical lift, over 5m with non-return valve fitted and when primed		
Port sizes	1" BSP-P or NPT		
Pump body	Steel		
Pump type	PTFE Gear		
Shaft	Stainless steel		
Seal	Fluoroelastomer		
Dimensions *	1000x800x300mm / 39x31.5x12in (1100x1000x400mm / 43x39x16in when in enclosure)		
Weight *	42kg/93lbs approx. (75kg/165lbs when in enclosure)		

**CLEANING SPEED**

Up to 26 lit/min,
ideal for tank sizes
from 10,000-30,000 L litres

**POWER**

220v AC, 24vDC,
110vAC

**INSTALLATION**

Wall Mounted, stair climbing trolley, weather-proof casing, towing unit, frame mounted

**ADD-ONS**

Absolute Polishing (to 0.5 micron), auto biocide dosing, WASP Connect (remote control of unit), particulate counter, Auto priming pumps, auto water drains, mobile & internet connectivity, drip tray, auto change-over for multiple fuel tanks, ModBus and FieldBus options

* Measurements are for the wall mounted version. Please enquire for measurements for others.

**BMS -Building Management System

*** approximate values

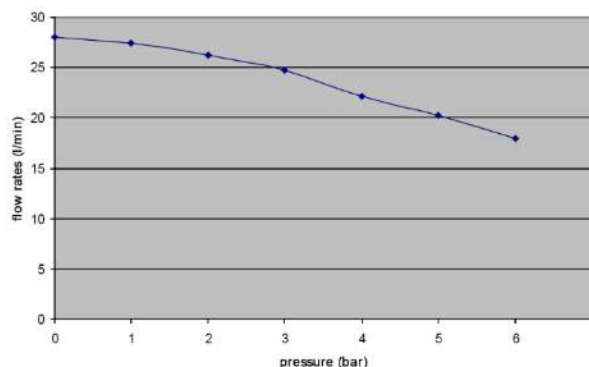



W-PFS-040

Up to 40 litres per minute fuel polishing system, cleaning fuel to 2 micron, removing both free and emulsified water, bacteria and particulate.

- Diesel/EN590/HVO/Biodiesel fuel polishing system
- Advanced, high speed DC system, providing full control system and monitoring
- Manual, Automatic (timer) and BMS control system
- Fuel conditioning stage for anti-bacterial action
- Patented centrifugal removal process
- Recirculation or transfer action
- 99.9 % free water removal in a single pass
- 99 % emulsified water removal in a single pass
- 2 micron final polish/fuel cleaning
- Tank sizes up to 50,000 litres

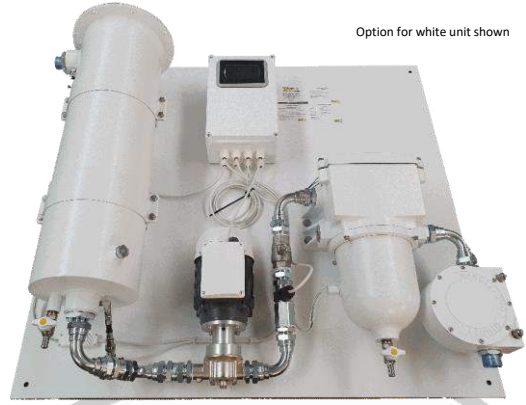

Base Model (wall mounted)	W-PFS-040-W-220VAC	W-PFS-040-W-110VAC
Max flow rate	up to 40 lit/min, 10.5 US gal/min	
Recommended tank size	up to 50,000 litres (13,200 us gallons)	
Finish options	Wall mounted, stair climbing trolley, weather-proof casing, towing unit	
Particulate removal to	2 Micron	
Control unit	Touch screen control	
BMS** outputs	6	
BMS** inputs	2	
Power options	220v 50hz 1ph AC	110v 60hz 1ph AC
Fuse	5a	10a
Typical current	2a	4a
Suction capability	1.5m vertical lift, over 5m with non-return valve fitted and when primed	
Port sizes	1" BSP-P or NPT	
Pump body	Steel	
Pump type	PTFE Gear	
Shaft	Stainless steel	
Seal	Fluoroelastomer	
Dimensions *	1100x1000x400mm / 43x39x16in (1100x1000x400mm/43x39x16in when in enclosure)	
Weight *	65kg / 143lbs approx. (98kg / 216lbs when in enclosure)	



CLEANING SPEED
Up to 40 lit/min,
ideal for tank sizes
from 25,000-50,000 L litres



POWER
220v AC
110v AC



INSTALLATION
Wall Mounted, stair climbing trolley, weather-proof casing, towing unit, frame mounted



ADD-ONS
Absolute Polishing (to 0.5 micron), auto biocide dosing, WASP Connect (remote control of unit), particulate counter, Auto priming pumps, auto water drains, mobile & internet connectivity, drip tray, auto change-over for multiple fuel tanks, ModBus and FieldBus options

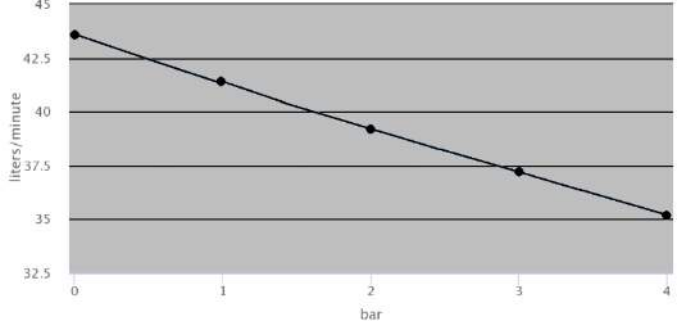

* Measurements are for the wall mounted version. Please enquire for measurements for others.
**BMS -Building Management System
*** approximate values





W-PFS-060

Up to 60 litres per minute fuel polishing system, cleaning fuel to 2 micron, removing both free and emulsified water, bacteria and particulate.

- Diesel/EN590/HVO/Biodiesel fuel polishing system
- Advanced, high speed DC system, providing full control system and monitoring
- Manual, Automatic (timer) and BMS control system
- Fuel conditioning stage for anti-bacterial action
- Patented centrifugal removal process
- Recirculation or transfer action
- 99.9 % free water removal in a single pass
- 99 % emulsified water removal in a single pass
- 2 micron final polish/fuel cleaning
- Tank sizes up to 100,000 litres



Base Model (wall mounted)	W-PFS-060-W-220vac	W-PFS-060-W-110vac
Max flow rate	up to 60 lit/min, 16 US gal/min	
Recommended tank size	Up to 100,000 litres (26,500 us gallons)	
Finish options	Wall mounted, enclosure, frame, trolley, and towing options	
Particulate removal to	2 Micron	
Control unit	Colour touch screen	
BMS** outputs	6	
BMS** inputs	2	
Power options	220v 50hz 1ph AC	110v 60hz 1ph AC
Fuse	5a	10a
Typical current	3a	6a
Suction capability	1.5m vertical lift, 5m with non-return valve fitted and when primed	
Port sizes	1.5" BSP-P or NPT	
Pump body	Stainless Steel	
Pump type	Sliding Vane	
Shaft	Stainless Steel	
Seal	Viton	
Dimensions *	1200x1000x400mm / 47x39x16in (1100x1000x400mm/43x39x16in when in enclosure)	
Weight *	75kg/165lbs approx. (108kg/238lbs when in enclosure)	



CLEANING SPEED

Up to 60 lit/min - ideal for tank sizes up to 100,000 litres



POWER

220v AC
110v AC



INSTALLATION

Wall Mounted, stair climbing trolley, weather-proof casing, towing unit, frame mounted



ADD-ONS

Absolute Polishing (to 0.5 micron), auto biocide dosing, WASP Connect (remote control of unit), particulate counter, Auto priming pumps, auto water drains, mobile & internet connectivity, drip tray, auto change-over for multiple fuel tanks, ModBus and FieldBus options

Performance curve available on request



* Measurements are for the wall mounted version. Please enquire for measurements for others.

**BMS -Building Management System

*** approximate values

Note, whilst a 10-micron element is available for the grey filter of this unit, to avoid unit slow-down we recommend only using the 60 or 30 micron elements in the grey filter



W-PFS-120

Up to 120 litres per minute fuel polishing system, cleaning fuel to 2 micron, removing both free and emulsified water, bacteria and particulate.

- Diesel/EN590/HVO/Biodiesel fuel polishing system
- Manual, Automatic (timer) and BMS control system
- Fuel conditioning stage for anti-bacterial action
- Patented centrifugal removal process
- Recirculation or transfer action
- Automatic stop on service requirement
- 99.6 % free water removal (in single pass)
- 99% emulsified water removal (in single pass)
- 2 micron fuel cleaning
- History trend function and report export option
- Units are IP55 and of open steel frame construction



Base Model (wall mounted)	W-PFS-120-F-220vac (110v AC version available on request)
Max flow rate	up to 120 lit/min (32 us gal/min)
Recommended tank size	Up to 250,000 litres (66,000 us gallons)
Finish options	Frame mount
Particulate removal to	2 Micron
Control unit	Colour Touch Screen
BMS** outputs	6
BMS** inputs	2
Power options	220v 50hz 1ph 12a (110v 50hz 60hz available on request)
Fuse	12a
Typical current	8a
Suction capability	1.5m vertical lift, over 5m with non-return valve fitted and when primed
Port sizes	2" BSP-P or NPT
Pump body	Stainless Steel
Pump type	Stainless Steel Centrifugal
Shaft	Stainless steel
Seal	Viton
Dimensions *	1000x1500x1800mm (40x59x71in)
Weight *	345kg approx. (760lbs)



CLEANING SPEED
Up to 120 lit/min - ideal for tank sizes up to 250,000 litres



POWER
220v AC
110v AC



INSTALLATION
Frame mounted (standard), weather-proof uPVC enclosure



ADD-ONS
Absolute Polishing (to 0.5 micron), auto biocide dosing, WASP Connect (remote control of unit), particulate counter, Auto priming pumps, auto water drains, mobile & internet connectivity, drip tray, auto change-over for multiple fuel tanks, ModBus and FieldBus options

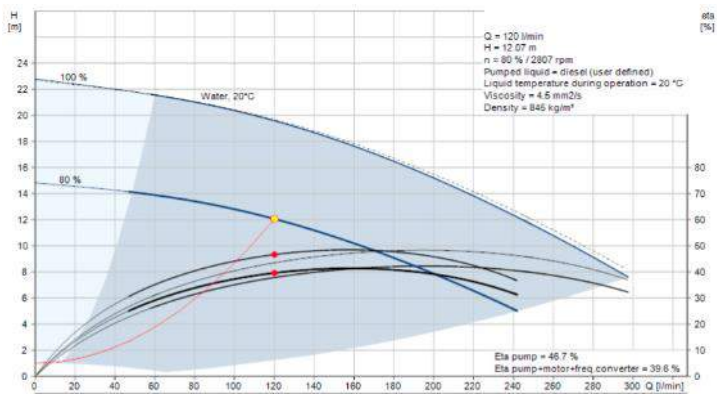

* Measurements are for the wall mounted version. Please enquire for measurements for others.
**BMS -Building Management System
*** approximate values



W-PFS-240

Up to 240 litres per minute fuel polishing system, cleaning fuel to 2 micron, removing both free and emulsified water, bacteria and particulate.

- Diesel/EN590/HVO/Biodiesel fuel polishing system
- Manual, Automatic (timer) and BMS control system
- Fuel conditioning stage for anti-bacterial action
- Patented centrifugal removal process
- Recirculation or transfer action
- Automatic stop on service requirement
- 99.6 % free water removal (in single pass)
- 99% emulsified water removal (in single pass)
- 2 micron fuel cleaning
- History trend function and report export option
- Units are IP55 and of open steel frame construction



Base Model (wall mounted)	W-PFS-240-F-220vac (110v AC version available on request)
Max flow rate	up to 240 lit/min (63.5 us gal/min)
Recommended tank size	up to 500,000 Litres (132,000 us gallons)
Finish options	Frame mount
Particulate removal to	2 Micron
Control unit	Touch screen control
BMS** outputs	6
BMS** inputs	2
Power options	220v 50hz 1ph (110v 60hz 1ph AC available on request)
Fuse	13a
Typical current	9a
Suction capability	1.5m vertical lift, over 5m with non-return valve fitted and when primed
Port sizes	2" BSP-P male or NPT
Pump body	Stainless Steel
Pump type	Stainless Steel Centrifugal
Shaft	Stainless Steel
Seal	Viton
Dimensions *	2000x1500x1800mm approx. (79x59x71in)
Weight *	550kg approx. (1212lbs)



CLEANING SPEED

Up to 240 lit/min - ideal for tank sizes up to 500,000 litres



POWER

220v AC
110v AC



INSTALLATION

Frame mounted (standard), uPVC enclosure



ADD-ONS

Absolute Polishing (to 0.5 micron), auto biocide dosing, WASP Connect (remote control of unit), particulate counter, Auto priming pumps, auto water drains, mobile & internet connectivity, drip tray, auto change-over for multiple fuel tanks, ModBus and FieldBus options

* Measurements are for the wall mounted version. Please enquire for measurements for others.

**BMS -Building Management System

*** approximate values

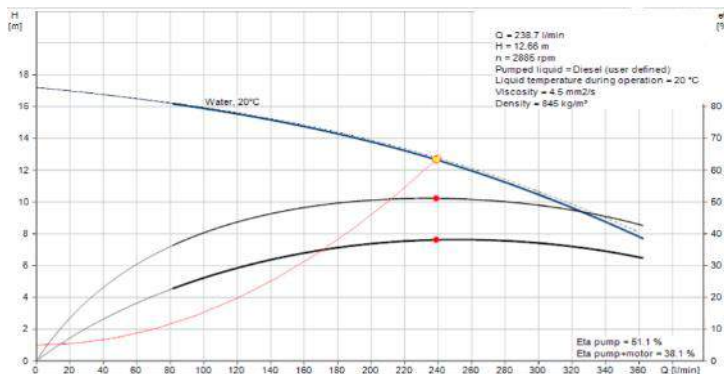



W-PFS add-on options

We realise each application may have different requirements and have therefore developed a range of “Add-ons” to customise a fuel polishing solution to tick all the boxes.

As we have an in-house team of experienced engineers, we are able to offer solutions which are not covered on the list if something you require is not listed, please contact us.

STAINLESS STEEL ENCLOSURE

For more prestigious locations and where mounting outside is critical, we offer an optional **stainless-steel enclosure**. This IP54 enclosure is supplied with thermostatic ventilation, a frost protection heater, and a leak detection system.



STAINLESS STEEL MOUNTING FRAME

The W-PFS range is designed to be wall mounted, but the standard and enclosed units can also be supplied with this sturdy **stainless-steel frame** to allow for simple floor mounting.



TROLLEY MOUNTING (portable)

Wall mounted systems are designed for use with fixed tanks, however for multiple tanks a **portable solution** is also available. This option allows you to take your W-PFS range fuel polishing system with you, it is also supplied with 2x 5m of hose to connect to your fuel tank.



TOWING UNIT ENCLOSURE

Whilst our standard portable solution suits most customers, some may prefer more ruggedised or towable portable units. To serve this requirement, we offer 4-wheel frame mounted units, with an optional towing connection. Such applications include multiple tanks on a large facility where small quad bikes are used to transport the polishing system, or for use in areas where a more resilient unit is needed, such as Africa.





ABSOLUTE POLISHING

If the need is for ultra-fine filtration, we offer 1 micron and 0.5 micron final stage filters. These units, known as **Absolute Polishing**, remove particulate at unparalleled levels in the market. Removing bacteria at a cellular level and ensuring fuel is clear and bright.

DRIP TRAY

If your system is installed in a location where spills may occur, this stainless-steel drip tray, mounted to the bottom edge of the system, is an effective and attractive solution to avoid spills.

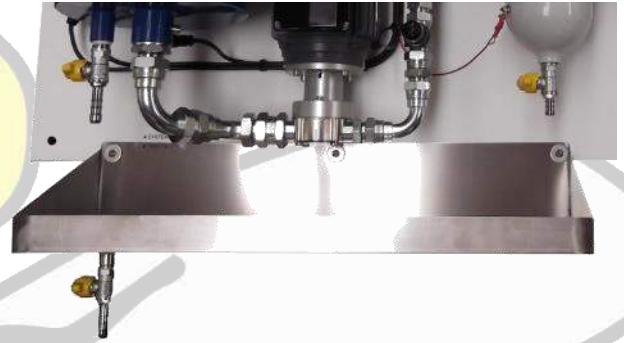

DOSING SYSTEM

Dosing fuel additives need not be an issue. Why deal with messy or hazardous chemicals when our **dosing system** can do it for you. Simply select the dosing amount you require and this unit, linked to your fuel polishing system, accurately injects the correct amount of your chosen liquid into the fuel. This is supplied with a stainless-steel tank and a level detect system to warn when the tank is empty.



PARTICULATE COUNTER

ISO4406 particulate counting with in-line monitoring, reporting and storage functions. If you need to know the quality of your fuel, this particulate counter will ensure a record is kept. Built in alarms allow you to set beacons or sounders, or even trigger more fuel polishing if the fuel quality at the sample point drops. There is even an export function to take your reports into excel.



ETHERNET CONNECTIVITY

Connectivity is the modern world, not only do WASP offer BMS connections via volt free contacts, but our **WASP connect** system allows you to remotely control and monitor your touch screen system on external devices. Using desktop sharing or a java enabled web browser, you can then view and interact with the copy of the touch screen as if you were standing in front of your system. W-PFS units are also supplied with volt free contacts for BMS communication as well as RS485 monitoring and control as standard.



PRIMING STAGE

Priming is vital for any pumped system, and whilst our ranges can assist to a point, we always recognise that priming should be completed as part of the installation process. Sometimes it may be required if the unit and its pipe work has been drained too. To take the work out of priming, we offer this automatic priming solution, which when fitted to the system's output, can be left in situ. Then, priming simply becomes a matter of pressing one button on a manual system. Meanwhile, the fully automatic system will work with the polishing system to gauge if fuel is flowing, if not, it will automatically activate the priming stage until fuel is observed then restart the polishing system.



MODBUS BMS AND FIELD BUS OPTIONS

W-PFS systems can communicate to fieldbus systems via volt-free contacts, however some sites require additional communication protocols. To assist, we offer a range of compatible systems including ModBus, ProfiBus, BACnet, CanBus and others. These interfaces take the standard input/output communication system and convert it to a protocol compatible with the customers required BMS system



AUTOMATIC WATER DRAINS

All systems are provided with internal water/sludge traps which hold the contamination until manual draining can take place. However, some customers may prefer our automatic water drain add-on. This clever system interacts with the main control unit and will autonomously evacuate water from the system when in operation. Its process varies depending on the water trap which requires emptying, however the integrated system will pause the main polishing pump and eject the water from the machine into a container of the customer's choice. Bringing you the benefits of the WASP cleaning process, with minimal operator interaction.



MULTI-TANK CHANGEOVER

The fuel polishing system is designed to process fuel in one tank. However, it is possible to allow it to clean fuel in 2, 3 or more tanks via our **automatic change over add-on**. This clever integrated technology works with the fuel polishing system to dictate which tank the system will clean autonomously, thus removing the need for engineer system setup and saving the cost of purchasing multiple machines for multiple tanks.





W-PFS Service packs and spares

We offer complete and element service packs for all W-PFS range machines, where our complete service pack is sufficient for your annual service. please see below for more details.

W-PFS-008/010-CSP	complete service pack for W-PFS-008/010
W-PFS-014-CSP	complete service pack for W-PFS-014
W-PFS-026-CSP	complete service pack for W-PFS-026
W-PFS-040-CSP	complete service pack for W-PFS-040
W-PFS-060-CSP	complete service pack for W-PFS-060
W-PFS-120-CSP	complete service pack for W-PFS-120
W-PFS-240-CSP	complete service pack for W-PFS-240

W-PFS-008/010-ESP	Element only service pack for W-PFS-008/010
W-PFS-014-ESP	Element only service pack for W-PFS-014
W-PFS-026-ESP	Element only service pack for W-PFS-026
W-PFS-040-ESP	Element only service pack for W-PFS-040
W-PFS-060-ESP	Element only service pack for W-PFS-060
W-PFS-120-ESP	Element only service pack for W-PFS-120
W-PFS-240-ESP	Element only service pack for W-PFS-240



Pressure Transducer (W-PFS-PS-0010)

Voltage output	0v to 10v DC
Pressure range sensed	0 to 10 barG
Supply voltage	12v to 30v DC (4.5ma max)
Port	1/8" NPTF male (to fit W-FCF filter)
Electrical Connection	Industrial DIN
Long term drift	0.2% FS/YS (non-cumulative)
Accuracy	0.25% FS
Thermal Error	1.5% FS/100 deg C
Operating Temperatures	-40 to +125 deg C
Zero / Span Tolerance	0.5% span
Response Time	1ms
Fatigue Life	Designed for more than 100,000,000 cycles
Wetted Parts	Stainless Steel
Protection	IP67
Vibration	40G peak to peak sinusoidal
EMC	100V/m
eight	35g

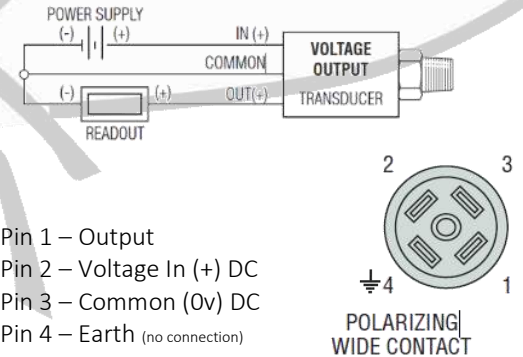

Water in fuel sensor (SWPG724)

Power	10-32v DC
Output	Switches to ground on water detection
Connection	PG7 (1/2"x20UNF)
Adaptors	M18 to PG7 available
Body	Black epoxy resin
Temperature	-40 to +125 deg C

Black wire	Supply voltage (+) DC
Green wire	Ground (0v) DC
White wire	Output

Approximate dimensions

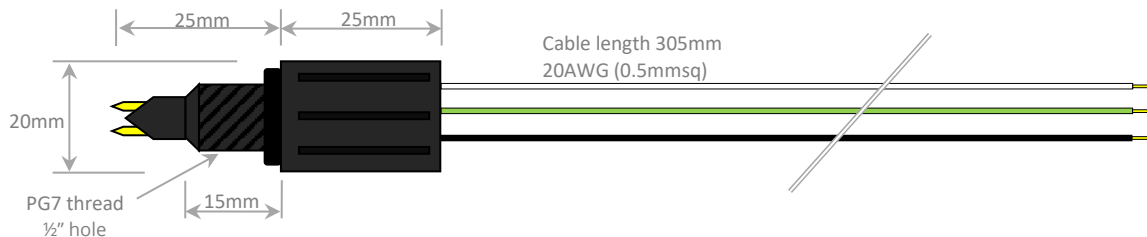

Vacuum Switch (C-Vac-Switch-Adj)

Adjusting range	200 - 900 mbar vacuum
Thread	1/4" BSP male taper
Protection cap black	NBR
Membrane	Viton
Body	Tropicalized steel
Max Voltage	48v
Max Current	0.5a (resistive), 0.2a (inductive)
Temp range	-5 to +60 deg C
Protection	IP54 with cap

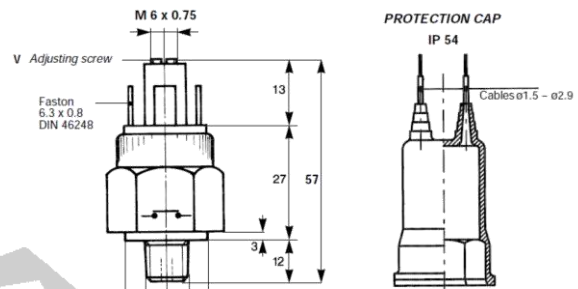

Pressure Switch (C-Press-Switch-Adj)

Adjusting range	1-10bar pressure
Thread	1/4" BSP male parallel
Protection cap black	NBR
Membrane	Viton
Body	Tropicalized steel
Max Voltage	48v
Max Current	0.5a (resistive), 0.2a (inductive)
Temp range	-5 to +60 deg C
Protection	IP54 with cap

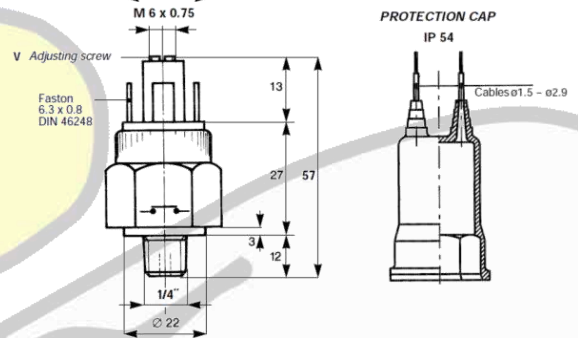

WASP 304 Stainless Steel Non-Return Valves

Suitable for use in a wide range of applications due to the rugged design and the materials of construction. 304 Stainless Steel body, Viton seal, BSPP female inlet, Max working temperature 150°C Min working temperature -20°C. Opening Pressure 0.03bar

Part Number	Size (BSP-P)	Max Working Pressure (Bar)	A (inches)	B (mm)	C (mm)	PN bar (nominal pressure)	Weight (g)
W-NRV-034	3/4"	35	3/4	45	72	16	142
W-NRV-100	1"	35	1	53	88	16	197
W-NRV-114	1-1/4"	30	1 1/4	62	99	16	320
W-NRV-112	1-1/2"	30	1 1/2	78	117	16	400
W-NRV-200	2"	24	2	85	115	16	676
W-NRV-212	2-1/2"	24	2 1/2	106	127	16	1075
W-NRV-300	3"	20	3	128	140	16	1630
W-NRV-400	4"	20	4	163	167	16	2270

Please note that a correction factor should be applied to the working pressure above 20°C.

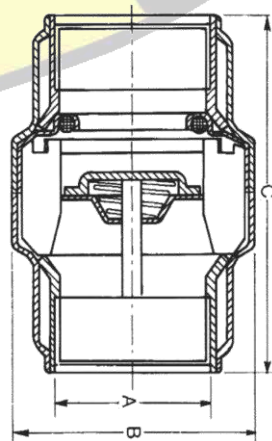

FRICION LOSSES DIAGRAMS

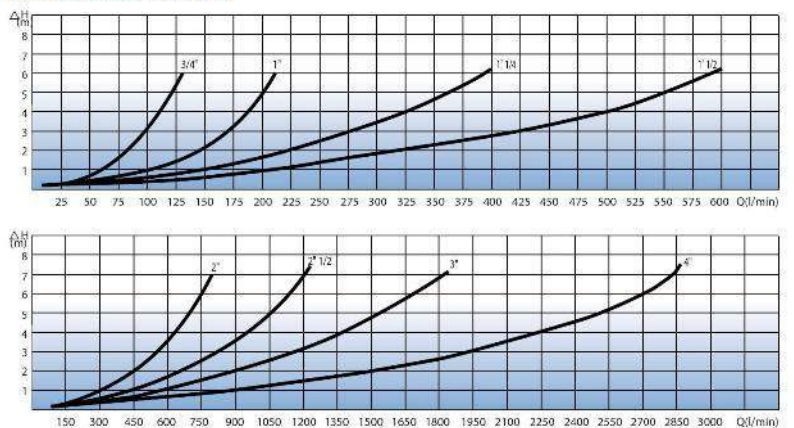

Custom built systems

Our in-house team of electrical and mechanical engineers have the expertise to custom build systems to your own specific requirements. If our standard range is not quite what you are looking for, please contact us and ask about our custom-built service.

Here are some previous examples:

FULL REDUNDANCY DUPLEX

The data centre customer who specified this W-PFS-060 requested full redundancy; hence this system has two of each stage, including with two complete distinct filtration paths.

- cleans at 60 litres per minute
- 220v 50hz 1ph powered (drawing roughly 12a)
- mounted in a stainless-steel frame
- automated ball valves, allowing one machine to clean 4 separate fuel tanks
- an integrated water tank
- pressure relief system
- fully monitored, remotely controlled and monitored via BMS with over 25 different sensing points, all monitoring the systems performance and operation
- integrated, monitored drip tray

Installation space was limited onsite, therefore space above the unit was allowed for servicing.

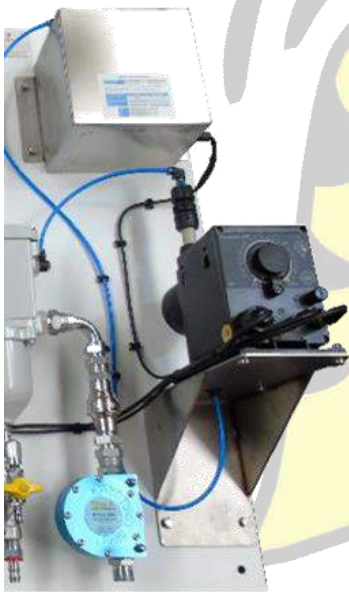

AUTOMATIC BIOCIDE DOSING

This W-PFS-060 system was supplied to a Data Centre in Turkey via our Turkish distributor, Evergee. To cope with poor quality fuel, they required all the benefits of a W-PFS system as well as biocide dosing as a preventative measure.

10 lit/min W-PFS SYSTEM WITH DOSING

This fuel polishing system complete with the dosing add-on had a requirement of being able to fit in a manhole. Our engineers worked with the customer to ensure the system could easily fit in the given installation area.



There is a larger collection of custom made systems within the W-PFS Premium Range. To see more examples, please visit www.wasp-pfs.com and view the [gallery](#).



WB Range

How does the WB range work?

By removing the bacterial content and neutralising any residual micro-fine particles, the infection simply cannot return; thus ensuring that the WASP Pure Fuel Systems are not only the most effective way of maintaining fuel quality, but is environmentally friendly too, as no chemicals or biocides are used in this process.

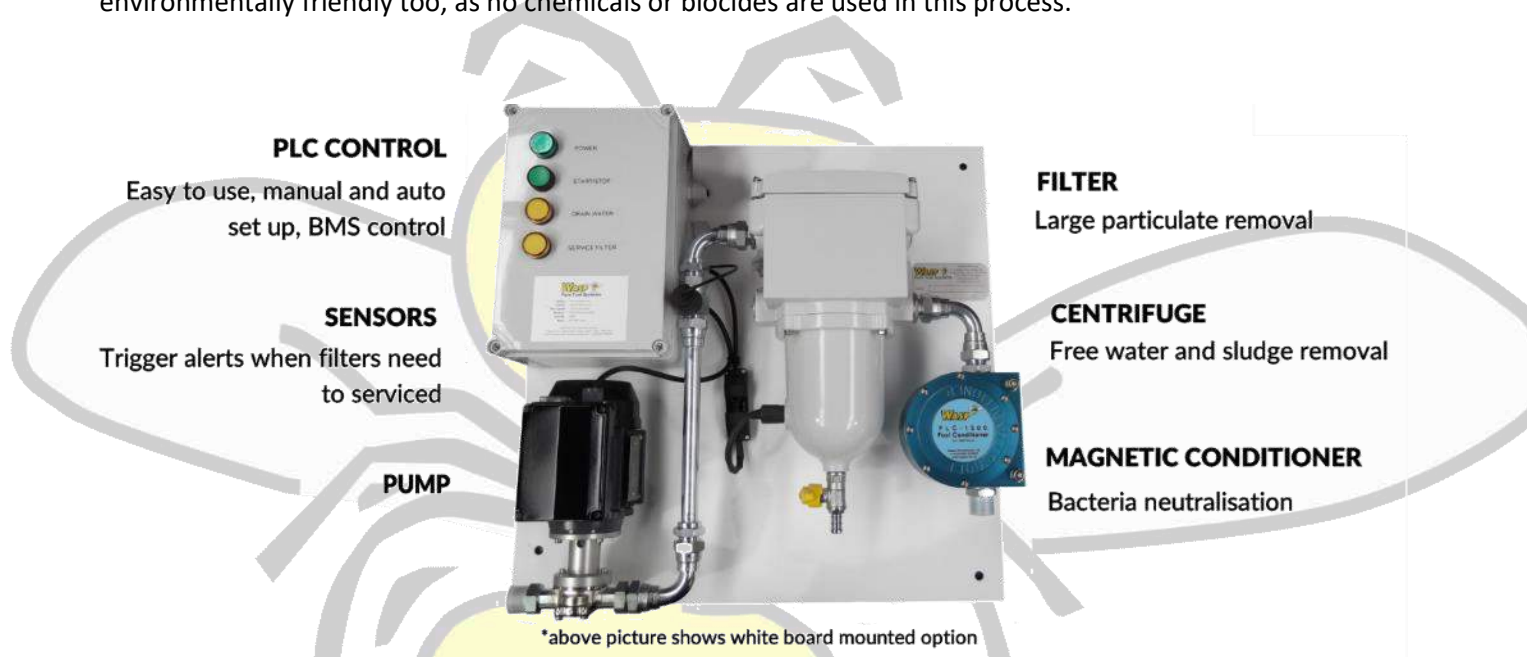

WB range service interval

Your WB range fuel polishing system should be serviced every 12 months, or sooner should the system ask for it. The service interval is 12 months; at that point a new set of elements and gaskets should be installed.

Should a service requirement for element change arise before then, please start your 12-month count from the insertion of a new element.

We also recommend you check the quality of your gaskets every 6 months and replace every 12 -36 months or at first signs of wear and tear.

Separate to the regular service, the system will flag if it requires any servicing or spare parts. This is via its built-in automatic monitoring system.

Your annual service should include:

- Grey Filter
- Element Replacement (Part required- see table below)
- Check gasket and replace if required (Part required- see table above)
- Drain water

The required spare parts for regular servicing are as follows:

	WB-10	WB-25	WB-40
Primary (grey filter) Element Part No	01010	01810	04010
Primary (grey filter) Seal Kit Part No	10528	30979	30980

30 Micron elements and 60-micron stainless steel elements are also available if required.



WB range installation guide

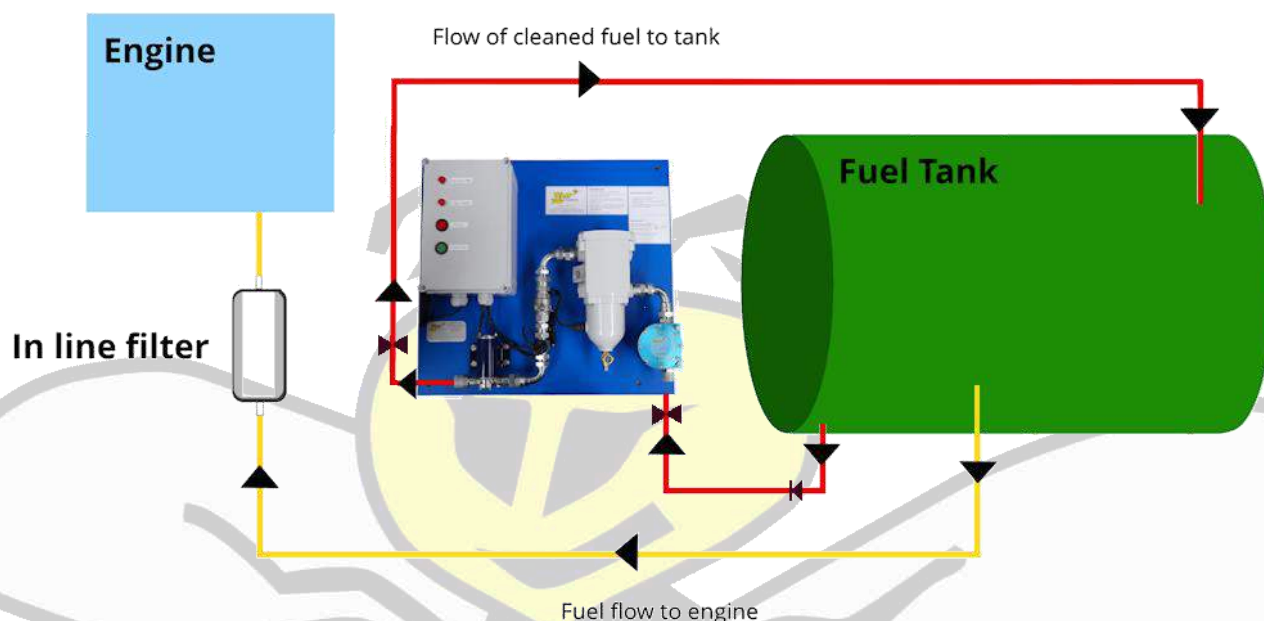

- Ensure the system is securely fastened to a wall or other suitable solid structure.
- The unit should have unique pipe work, i.e. not the feed to the engine.
- The input to the WASP system should feed from the bottom of the fuel tank (via a ball valve and a foot valve / non-return valve with an opening pressure of 0.05bar or less).
- The system should pick-up fuel from the lowest point of the tank at one end, (below the level of the fuel feed to your engine) and ideally return it to the highest point at the opposite end.
- In any typical fuel tank, the pipe feeding fuel to the engine is not at the bottom, however to successfully clean fuel, the pickup pipe going to the WB unit should be right at the bottom of the tank, below the engine feed.
- The output should return to the tank at the top, ideally the opposite end to the input.
- The unit can be controlled via BMS (Building Management System), however it is capable of self-operation and monitoring.
- System must be primed before use and operation. It must also be primed after servicing; although with the foot or non-return valve installed, priming should only need to be done once, after installation.
- With power applied, please ensure the system's time and date have been correctly set.
- We recommend an internal pipe diameter of 3/4" for WB-10 models, 1" for the WB-25/WB-40 models. Larger diameters will assist the unit as this reduces the frictional losses but will make priming more difficult. Small diameters, long pipe runs or many bends in the pipe work will cause high frictional losses and cause the system to run slower than its maximum speed, or in extreme cases cause it to stop. Likewise, high fuel lifts or fuel heads will also cause the unit to run slower,



WB-10

Up to 10 litres per/min fuel polishing system, cleaning fuel to 10 micron, removing free water, bacteria and particulate

- Advanced fuel filter/water separation technology
- 5 stage centrifugal filtration process
- Up to 10 litres per minute flow rate
- Ideal for up to 12,500 litre fuel tanks
- 220v 50hz 1ph AC, 110v 60hz 1ph AC, 24v DC or 12vDC
- 1 x BMS Output 2 x BMS Inputs
- Mounting options include wall, enclosure, stainless frame or portable trolley
- Automatic shutdown when servicing is required
- Manual and Automatic mode
- Simple remote monitoring



Base Model (wall mounted)	WB-10-12	WB-10-24	WB-10-110	WB-10-220
Max flow rate	up to 10 lit/min (2.6 us gal/min)			
Recommended tank size	up to 12,500 Litres (3,300 us gallons)			
Finish options	Wall Mounted, Enclosure, Trolley, Frame mounted			
Particulate removal to	10 Micron			
Control unit	PLC Control			
BMS** outputs	1			
BMS** inputs	2			
Power options	12v DC	24v DC	110v AC	220v AC (0.15kw)
Fuse	6a	3a	8a	4a
Typical current	2a	1a	3a	1a
Suction capability	5m max vertical with light spring non-return valve and priming			
Port sizes	3/4" BSP-P or NPT			
Pump body	Steel			
Pump type	PTFE Gear			
Shaft	Stainless steel			
Seal	Fluoroelastomer			
Dimensions *	700x600x240mm (27x23x10in)			
Weight *	16kg approx. (35lbs)	16kg approx. (35lbs)	19kg approx. (42lbs)	19kg approx. (42lbs)



CLEANING SPEED

Up to 10 lit/min - ideal for tank sizes up to 12,500 litres



POWER

220v AC, 12vDC 24vDC, 110vAC



INSTALLATION

Wall Mounted, stair climbing trolley, weather-proof casing, frame mounted



ADD-ONS

Drip tray, stainless steel or powder coated mild steel enclosure. frame mounting, beacon and sound alarms, portable options, pre-strainer, white mounting board and final stage filter

* Measurements are for the wall mounted version. Please enquire for measurements for others.

**BMS -Building Management System

*** approximate values

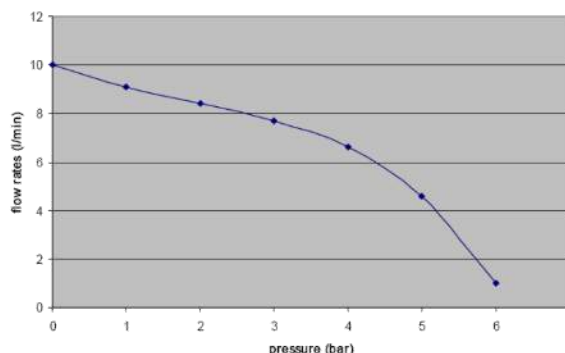
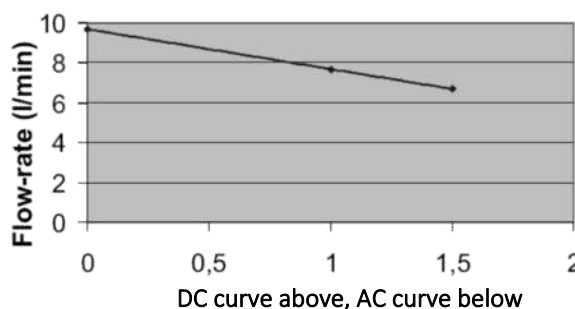



WB-25

Up to 25 litres per/min fuel polishing system, cleaning fuel to 10 micron, removing free water, bacteria and particulate

- Advanced fuel filter/water separation technology
- 5 stage centrifugal filtration process
- Up to 25 litres per minute flow rate
- Ideal for up to 30,000 litre fuel tanks
- 220v 50hz 1ph AC, 110v 60hz 1ph AC, 24v DC or 12vDC
- 1 x BMS Output 2 x BMS Inputs
- Mounting options include wall, enclosure, frame or portable trolley
- Automatic shutdown when servicing is required
- Manual and Automatic mode
- Simple remote monitoring



Base Model (wall mounted)	WB-25-12	WB-25-24	WB-25-110	WB-25-220
Max flow rate	up to 25 lit/min (6.6 US gal/min)			
Recommended tank size	up to 30,000 Litres (8,000 US gallons)			
Finish options	Wall Mounted, Enclosure, Trolley, Frame mounted			
Particulate removal to	10 Micron			
Control unit	PLC Control			
BMS** outputs	1			
BMS** inputs	2			
Power options	12v DC	24v DC	110v AC	220v AC (0.15kw)
Fuse	5a	2.5a	5a	2.5a
Typical current	2.2a	1a	3a	1.5a
Suction capability	5m max vertical with light spring non-return valve and priming			
Port sizes	1" BSP-P male or NPT			
Pump body	Steel			
Pump type	PTFE Gear			
Shaft	Stainless steel			
Seal	Fluoroelastomer			
Dimensions *	700x700x350mm (27x27x14in)			
Weight *	19kg approx. (41lbs)	19kg approx. (41lbs)	21kg approx. (46lbs)	21kg approx. (46lbs)

CLEANING SPEED
Up to 25 lit/min - ideal for tank sizes up to 30,000 litres

POWER
220v AC, 12vDC
24vDC, 110vAC

INSTALLATION
Wall Mounted, stair climbing trolley, weather-proof casing, frame mounted

ADD-ONS
Drip tray, stainless steel or powder coated mild steel enclosure. frame mounting, beacon and sound alarms, portable options, pre-strainer, white mounting board and final stage filter

* Measurements are for the wall mounted version. Please enquire for measurements for others.
**BMS -Building Management System
*** approximate values

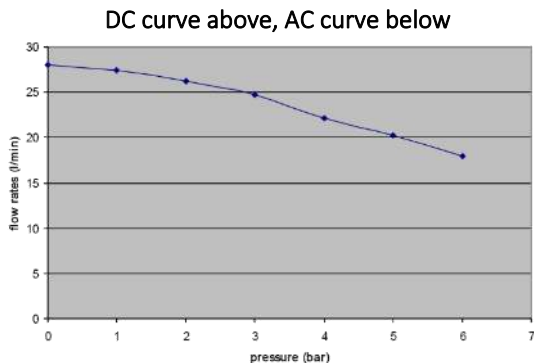
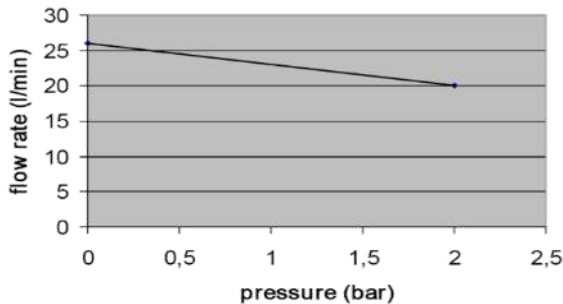



WB-40

Up to 40 litres per/min fuel polishing system, cleaning fuel to 10 micron, removing free water, bacteria and particulate

- Advanced fuel filter/water separation technology
- 5 stage centrifugal filtration process
- Up to 40 litres per minute flow rate
- Ideal for up to 50,000 litre fuel tanks
- 220v 50hz 1ph AC, 110v 60hz 1ph AC, 24v DC or 12vDC
- 1 x BMS Output 2 x BMS Inputs
- Mounting options include wall, enclosure, frame or portable trolley
- Automatic shutdown when servicing is required
- Manual and Automatic mode
- Simple remote monitoring



Base Model (wall mounted)	WB-40-12	WB-40-24	WB-40-110	WB-40-220
Max flow rate	up to 40 lit/min (10.5 US gal/min)			
Recommended tank size	up to 50,000 Litres (13,200 US gallons)			
Finish options	Wall Mounted, Enclosure, Trolley, Frame mounted			
Particulate removal to	10 Micron			
Control unit	PLC Control			
BMS** outputs	1			
BMS** inputs	2			
Power options	12v DC (on request)	24v DC	110v AC	220v AC (0.15kw)
Fuse	(on request)	2.5a	5a	2.5a
Typical current	(on request)	1a	3a	1.5a
Suction capability	5m max vertical with light spring non-return valve and priming			
Port sizes	1" BSP-P or NPT			
Pump body	Steel			
Pump type	PTFE Gear			
Shaft	Stainless steel			
Seal	Fluoroelastomer			
Dimensions *	600x900x350mm (24x35x14in)			
Weight *	26kg approx. (57lbs)	29kg approx. (64lbs)	29kg approx. (64lbs)	29kg approx. (64lbs)

**CLEANING SPEED**

Up to 40 lit/min - ideal for tank sizes

up to 50,000 litres

**POWER**

220v AC, 12vDC
24vDC, 110vAC

**INSTALLATION**

Wall Mounted, stair climbing trolley, weather-proof casing, frame mounted

**ADD-ONS**

Drip tray, stainless steel or powder coated mild steel enclosure. frame mounting, beacon and sound alarms, portable options, pre-strainer, white mounting board and final stage filter

* Measurements are for the wall mounted version. Please enquire for measurements for others.

**BMS -Building Management System

*** approximate values

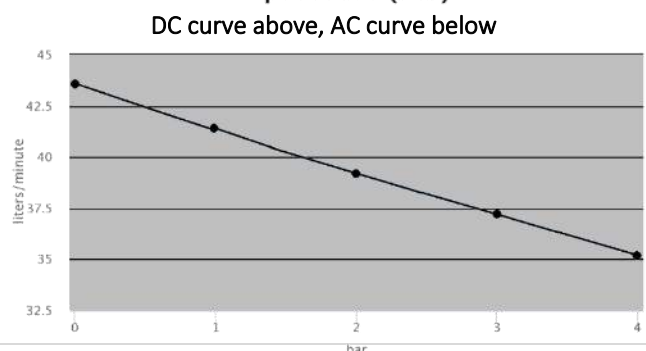
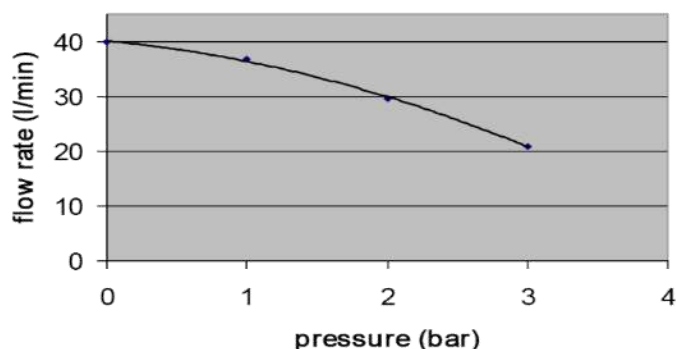



WB add on options

We realise each application may have different requirements and have therefore developed a range of “Add-ons” to customise a fuel polishing solution to tick all the boxes.

As we have an in-house team of experienced engineers, we can offer solutions which are not covered on the list. If something you require is not listed, please contact us.

POWDER COATED MILD STEEL ENCLOSURE

Weather proofing your system for mounting outside, this IP66 rated enclosure is the perfect solution to ensure your fuel polishing system can be placed as close to your tank as possible. This, our standard WB range enclosure, also features a locking door.



STAINLESS STEEL FRAME

The WB range is designed to be wall mounted, but the standard and enclosed units can also be supplied with this sturdy stainless-steel frame to allow for simple floor mounting. (Example shows “Powder Coated Mild Steel Enclosure” and “Stainless Steel Mounting Frame” Add-ons).



TROLLEY MOUNTING

Wall mounted systems are designed for use with fixed tanks, however for multiple tanks a portable solution is also available. This option allows you to take your WB range fuel polishing system with you, it is also supplied with 2x 5m of hose to connect to your fuel tank.



DRIP TRAY

If your system is installed in a location where spills may occur, this stainless-steel drip tray, mounted to the bottom edge of the system, is an effective and attractive solution to avoid spills.

BEACONS/ SOUNDERS

The WB range has lamps on the control panel to indicate service requirements, but an external beacon or sounder can also be added via the internal volt-free contact. This allows the alert to be raised in a different room, or control area.



WHITE MOUNTING BOARD

Our standard blue board helps to instantly recognise a WB range unit, however in some environments (for example yacht engine rooms), a white base may be more suited to the end customer expectations.



PRE-STRAINER

If your fuel is very dirty, you may wish to consider a WASP pre-strainer, before the input of your system. A 100-micron strainer will catch large contaminate, protecting your system and preserving the life of your filter element.



FINAL STAGE FILTER

Adding extra flexibility to the final clean, a range of water stop, 3, 10, and 30 micron elements can also be added to the output of the WB range to enhance the clean further.



WB Custom built systems

Our in-house team of electrical and mechanical engineers have the expertise to custom build systems to your own specific requirements. If our standard range is not quite what you are looking for, please contact us and ask about our custom-built service.

Here are some previous examples:

ATEX APPROVED

For use with Kerosene and liquids which require ATEX approved electronics or for use in ATEX zones, this polishing system is the ideal mix of simplicity and high-level filtration. Specifically designed with our class leading filtration solution, this simple to operate unit includes a fuel conditioning stage, a 100-micron pre-strainer, centrifugal fuel cleaning, water/sludge removal and a 10 or 30-micron final stage. A visual indication gauge gives filter life feedback, the unit is supplied with 2x 5m of hose and an ATEX approved 40 lit/min pump ensures compatibility with the appropriate standards.



PORTABLE WITH PRE-STRAINER

Our mobile solutions offer class leading filtration, but for some applications it is possible that the fuel quality is so poor, you may wish to remove the sludge and similar. To aid with this, we offer a 100 micron, washable pre-strainer filter. As the first thing the fuel reaches, this stainless-steel mesh filter removes large particulate and sludge before the fuel reaches the main filtration stages. To clean this unit, simply remove the internal stainless-steel element, clean with fresh diesel and replace it.



There is a larger collection of custom-made systems within the WB Classic Range. To see more examples, go to www.wasp-pfs.com and view the [gallery](#).



W10AC Fuel Polishing Range

Fuel Polishing, designed for customer re-badging

- 10, 6 or 3 micron fuel cleaning
- 8 lit/min max (2.1US gal/min)
- Free and emulsified water removal
- 220AC 50hz 1ph (or 110v 60hz 1ph AC on request)
- 2a max
- Control options available
- Connection 3/4" BSP-P male ports (NPT on request)
- Unit can be supplied un-branded if required
- Designed to allow customers to rebrand this product as their own
- Option for fuel conditioner
- Option for simple control system



W10ACIM shown

Designed with simplicity and customer integration in mind, the W10AC range of fuel polishing systems will meet the entry level for fuel polishing for applications such as small gen-sets, belly tanks, hotels, residential homes, fuel oil stores.

Mounted on either a white or blue base, and ready for customer mounting onto any hard, vertical surface; these systems offer simple yet effective fuel cleaning with control and non-internal control options. Designed to fit into your project both in engineering and in budgetary terms, these systems offer class leading filtration at the entry level of the market.

Model	Control	Conditioner	Weight*	Size*	Power	Ports
W 1 0 A C - - - -	-	-	10kg/22lbs	50 x 30 x 12cm	220vAC 50hz	3/4" BSP/NPT
W 1 0 A C I - - -	Simple	-	11kg/24lbs	60 x 50 x 12cm	220vAC 50hz	3/4" BSP/NPT
W 1 0 A C - M - -	-	Yes	13kg/28lbs	60 x 30 x 12cm	220vAC 50hz	3/4" BSP/NPT
W 1 0 A C I M - -	Simple	Yes	14kg/31lbs	60 x 50 x 12cm	220vAC 50hz	3/4" BSP/NPT

Intelligence

Magnetic conditioner

Touch screen

Reserved for future option

*approx.

Base models (no suffix)

Supplied with a switchable pump, to allow for simple on/off control. A clear polymer bowl allows the user to see how much water has been collected and stop the unit when appropriate. Service the filter when full, or every 6 months whichever occurs soonest. Units are supplied with 6-micron elements, unless otherwise specified at the time of ordering.

Conditioner models (suffix M)

In addition to the base model, conditioner models add the magnetic fuel protection system, aiding the removal of bacterial content and removing ferrous particles (such as rust) from the liquid as it passes through.

Simple control system (as per the image above) (suffix I)

In addition to the base model, this control unit adds a timer function, manual mode, pump on/off, water in fuel and service filter sensors. The system will start/stop based on its own timer but will stop and indicate a service requirement should one of the sensors trigger via LEDs inside the control box. Reset of alarms is via a power cycle.

Your W10AC range fuel polishing system should be serviced every 12 months, or sooner should the system ask for it. The service interval is 12 months; at that point a new set of elements and gaskets should be installed.

WASP PFS Ltd – the market leaders in fuel filtration equipment.

We invent, design and manufacture fuel filtration equipment including innovative fuel polishing systems and absolute polishing products.

Services include fuel testing, consultation, and training.

For more information on the product range, please visit our website www.wasp-pfs.com or email us sales@wasp-pfs.com americasales@wasp-pfs.com

WASP – for all your fuel cleanliness requirements

For more information and support for your fuel polishing system, please refer to your WASP Product Manual.

If you require further information, please contact Technical Support at WASP on
+44(0)1923 606600 (UK/EU)
+1(0) 309-981-0609 (Americas)

Alternatively, you can email support@wasp-pfs.com